

When you have inserted the revit file/family into your project you can mark the object you want to change. Marked object in blue.

Up to the left you can then change what object you want it to be. See red marking in picture.

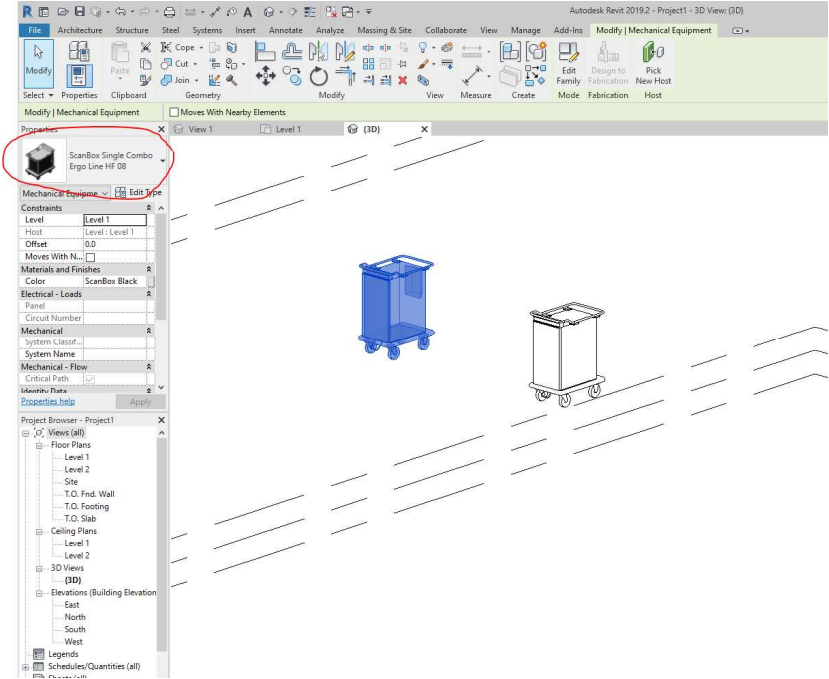

From start it is a Ergo Line single HF08.

Here I have changed it to a Banquet Line Combo CC06+HF06. And the blue one is changed. Obs the icon to the left is always the same. You have to look at the text to see what model it is. See in red marking.

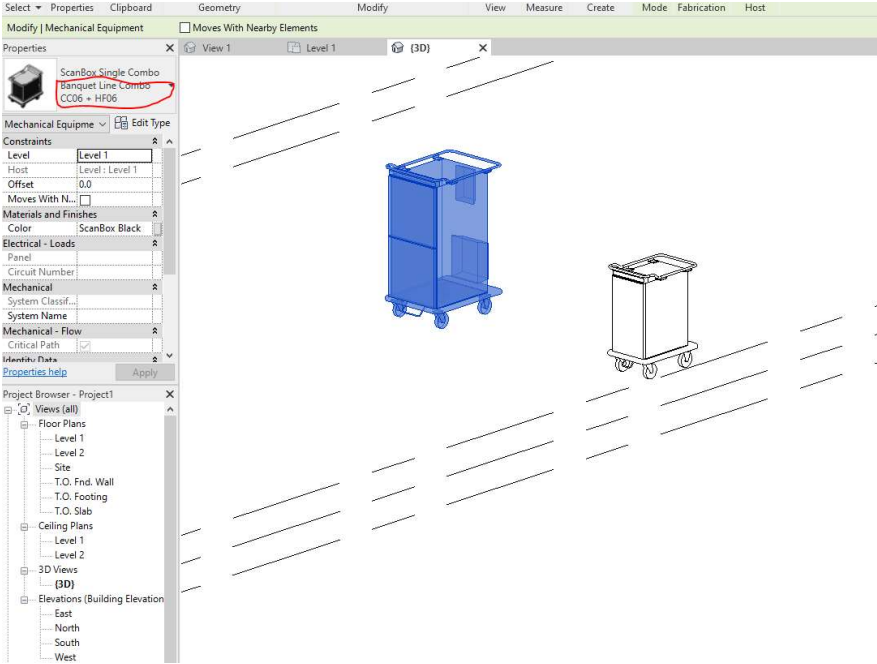

Here it is in coloured mode.

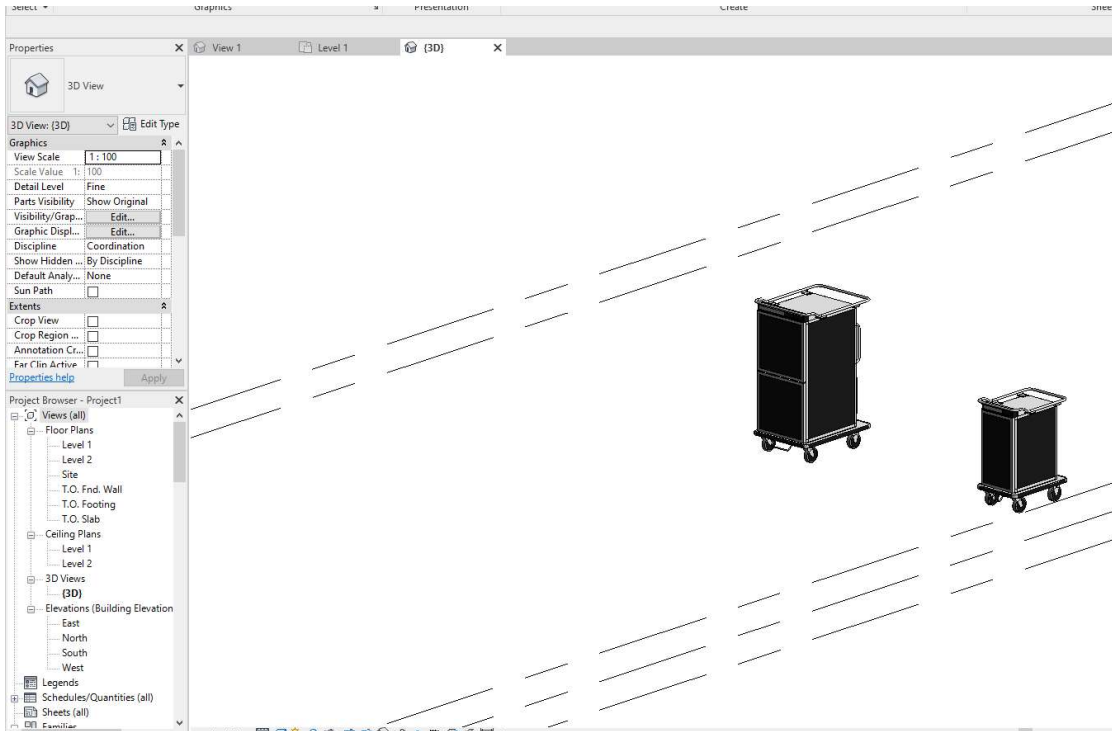

And here you can choose what colour you like.

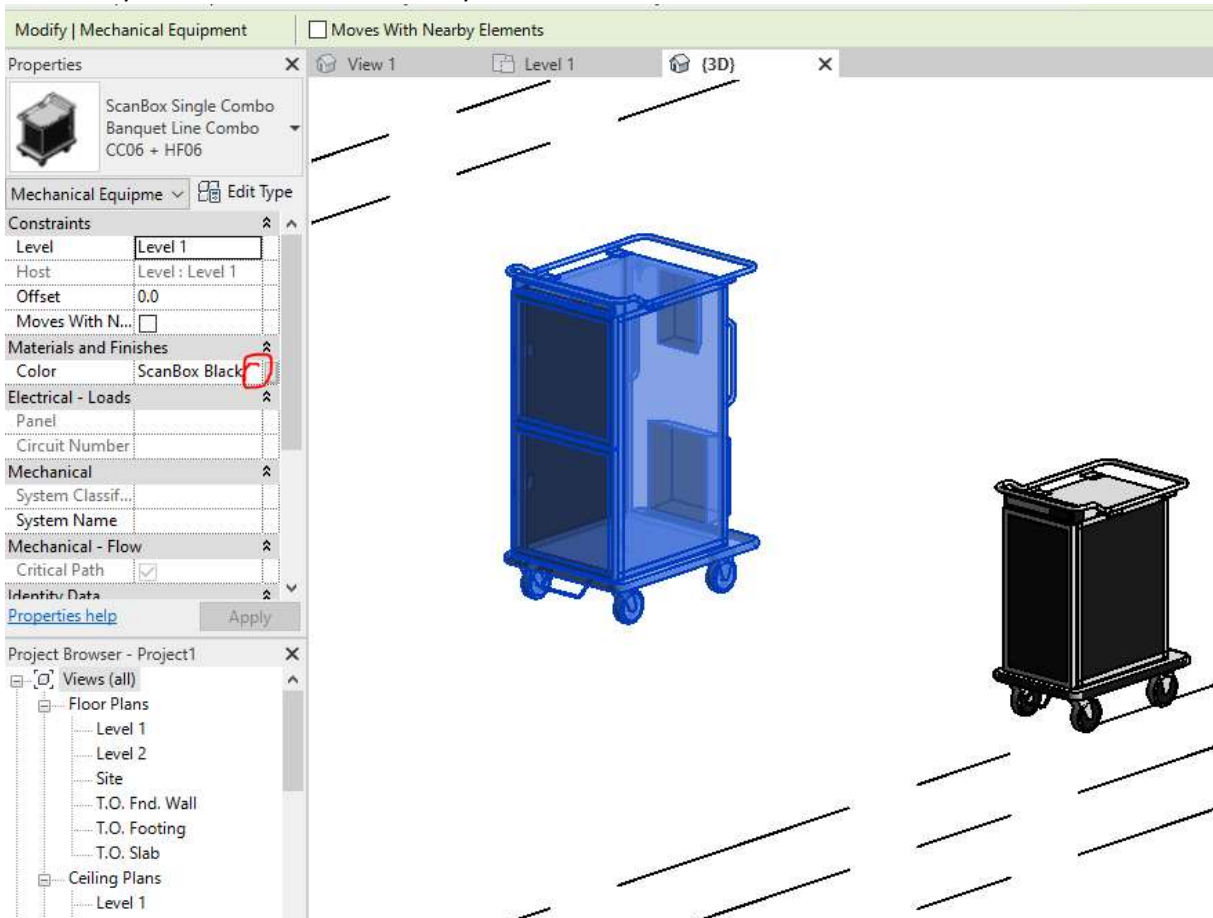

And you can have it Black, Grey or Red.

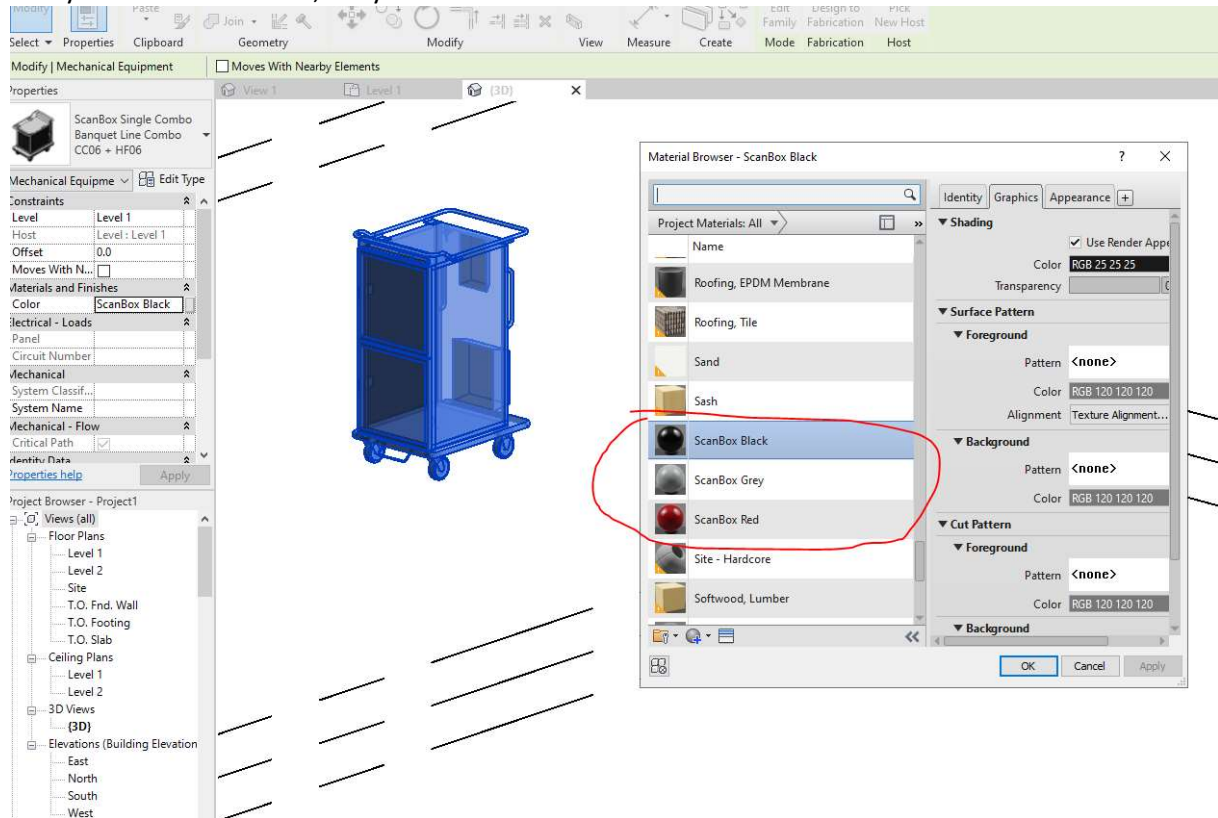

Red one.

